



basic education

Department:
Basic Education
REPUBLIC OF SOUTH AFRICA

NATIONAL SENIOR CERTIFICATE

GRADE 12

MECHANICAL TECHNOLOGY: FITTING AND MACHINING

NOVEMBER 2019

MARKING GUIDELINES

MARKS: 200

These marking guidelines consist of 23 pages.

QUESTION 1: MULTIPLE-CHOICE (Generic)

1.1	B ✓	(1)
1.2	C ✓	(1)
1.3	A ✓	(1)
1.4	C ✓	(1)
1.5	A ✓	(1)
1.6	C ✓	(1)
		[6]

QUESTION 2: SAFETY (Generic)

2.1 Machine safety rule:

- Know how to switch the machine off / emergency stop. ✓
- Wear personal protective equipment (PPE). ✓
- Know how to use the machine. ✓
- Ensure that all guards are in place. ✓
- No tools lying on the machine. ✓
- Work piece is properly secured. ✓
- Check the condition of the machine. ✓
- Follow manufacture's specifications before operating a machine. ✓
- Operator must have authorization to working on a machine. ✓
- Make sure the machine is not locked out. ✓
- Ensure that the machine setup is correct and safe. ✓
- Ensure that the machine area is clean and safe. ✓

(Any 1 x 1) (1)

2.2 Drill press safety precautions:

- To prevent injuries. ✓
- To improve accuracy. ✓
- To prevent work piece rotating / moving. ✓
- To prevent the drill bit from breaking. ✓

(Any 1 x 1) (1)

2.3 Hydraulic press safety rules:

- Make sure the press is in a good working condition. ✓
- Take notice of the pre-determined maximum pressure of the hydraulic press. ✓
- Make sure the area around the press is clean and free of oil, grease and water. ✓
- Ensure that the platform is rigid and square to the cylinder. ✓
- Ensure that suitable jigs and prescribed equipment is available. ✓
- Check hydraulic pipes for leaks or cracks. ✓
- Check supporting pins are not worn out and fitted properly. ✓
- Check fluid levels. ✓
- Compressive force must be applied at 90° to the object. ✓
- Check cable and pulleys on the platform if equipped. ✓
- Correct PPE. ✓
- Pressure gauge must be checked and calibrated. ✓
- Ensure that all guards are in place. ✓

(Any 2 x 1) (2)

2.4 Reasons for wearing surgical gloves:

- To prevent HIV/AIDS or any blood related infections being transmitted. ✓
- To prevent contamination of the open wounds. ✓

(2)

2.5 **Safe handling of portable electrical equipment:**

- Ensure the electrical cord and plug, are in a good condition. ✓
- Ensure all safety guards are in place. ✓
- Ensure that the correct attachments (drill bits, blades etc.) are fixed in the correct way. ✓
- Do not force the machine / equipment. ✓
- Operate according to manufacturer instructions. ✓
- Avoid contact with water. ✓
- Keep the cable away from heat, oil, sharp edges and moving parts. ✓
- Make sure that the wires don't wrap around each other. ✓
- Avoid dropping the machine. ✓
- Check the condition of the equipment. ✓

(Any 2 x 1) (2)

2.6 **Responsibility of employer:**

- Provide and maintain working systems, work area, equipment and tools in a safe condition. ✓
- Eliminate or reduce any potential hazard. ✓
- Produce, handle, store and transport goods safely. ✓
- Ensure that every person employed complies with the requirements of this OHS Act. ✓
- Enforce measures if necessary in the interest of health and safety. ✓
- Appoint a person who is trained and who have the authority to ensure that the employee takes precautionary measures. ✓
- Inform employees of the hazards to his health and safety attached to any duty or work situation. ✓
- Provide first aid equipment. ✓

(Any 1 x 1) (1)

2.7 **Responsibility of employee:**

- Pay attention to their own and other people's health and safety. ✓
- Co-operate with the employer regarding the OHS Act. ✓
- Carry out a lawful order given to them. ✓
- Report any situation that is unsafe or unhealthy. ✓
- Report all incidents and accidents. ✓
- Not to interfere with any safety equipment or misuse such equipment. ✓
- Obey all safety rules. ✓

(Any 1 x 1) (1)

[10]

QUESTION 3: MATERIAL (Generic)

3.1 Filing test:

- Use the right ✓ filing skills. ✓
- File on the tip or edge ✓✓ of the metal.
- By applying chalk ✓ to the file surface. ✓

(Any 1 x 2) (2)

3.2 Purpose of heat treatment of steel:

Heat treatment of steel is done to change ✓ the properties / grain structure ✓ of steel.

(2)

3.3 Reasons for tempering hardened steel:

- To reduce ✓ the brittleness ✓ caused by the hardening process.
- To relieve ✓ strain ✓ caused during hardening process.
- To increase ✓ the toughness ✓ of the steel.
- To give hardened work piece a more ✓ fine-grained structure. ✓

(Any 2 x 2) (4)

3.4 Heat treatment processes on steel:

3.4.1 Annealing:

- The steel is heated to the prescribed temperature. ✓
- The steel is soaked at that temperature for the required time. ✓
- The steel is then cooled very slowly to produce maximum softness. ✓

(3)

3.4.2 Hardening:

- The steel is heated slightly higher than the upper critical temperature. (AC_3) ✓
- The steel is soaked at that temperature for the required time. ✓
- The steel is then rapidly cooled by quenching in rapid cooling medium. ✓

(3)

[14]

QUESTION 4: MULTIPLE-CHOICE QUESTIONS (Specific)

- | | | |
|------|---------|-------------|
| 4.1 | A ✓ | (1) |
| 4.2 | D ✓ | (1) |
| 4.3 | B / A ✓ | (1) |
| 4.4 | A ✓ | (1) |
| 4.5 | B / A ✓ | (1) |
| 4.6 | B ✓ | (1) |
| 4.7 | B ✓ | (1) |
| 4.8 | A ✓ | (1) |
| 4.9 | C ✓ | (1) |
| 4.10 | B ✓ | (1) |
| 4.11 | D ✓ | (1) |
| 4.12 | B ✓ | (1) |
| 4.13 | A ✓ | (1) |
| 4.14 | B ✓ | (1) |
| | | [14] |

QUESTION 5: TERMINOLOGY (Lathe and Milling Machine) (Specific)

5.1 Taper turning:

5.1.1 Small diameter:

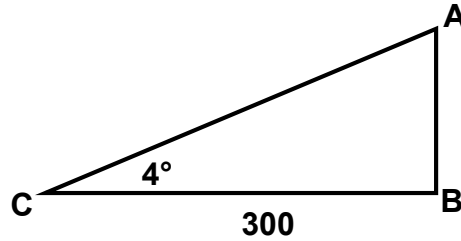

$$\tan \frac{\theta}{2} = \frac{AB}{300} \quad \checkmark$$

$$AB = \tan 4^\circ \times 300 \\ = 20,98 \text{ mm} \quad \checkmark$$

$$d = D - 2(AB) \quad \checkmark \\ = 200 - 2(20,98) \quad \checkmark \\ = 158,04 \text{ mm} \quad \checkmark$$

OR

$$\tan \frac{\theta}{2} = \frac{D - d}{2L} \quad \checkmark$$

$$\tan 4^\circ = \frac{200 - d}{2(300)} \quad \checkmark$$

$$\tan 4^\circ \times 600 = 200 - d \quad \checkmark \\ d = 200 - (\tan 4^\circ \times 600) \quad \checkmark \\ d = 158,04 \text{ mm} \quad \checkmark$$

OR

$$d = D - 2AB \quad \checkmark \\ = 200 - 2(300 \times \tan 4^\circ) \quad \checkmark \checkmark \checkmark \\ = 158,04 \text{ mm} \quad \checkmark$$

(5)

5.1.2 **Setting over of tailstock:**

Setting over : 20,98 mm over 300 mm

Thus "X" mm over 400 mm

$$300" X" = 20,98 \times 400 \quad \checkmark$$

$$"X" = \frac{20,98 \times 400}{300} \quad \checkmark$$

$$"X" = 27,97 \text{ mm} \quad \checkmark$$

OR

$$\text{Set over} = \frac{L(D-d)}{2l} \quad \checkmark$$

$$= \frac{400(200 - 158,04)}{2(300)} \quad \checkmark$$

$$= 27,97 \text{ mm} \quad \checkmark$$

(3)

5.2 **Parallelkey:**

5.2.1 **Width:**

$$\text{Width} = \frac{D}{4}$$

$$= \frac{42}{4} \quad \checkmark$$

$$= 10,5 \text{ mm} \quad \checkmark$$

(2)

5.2.2 **Thickness:**

$$\text{Thickness} = \frac{D}{6}$$

$$= \frac{42}{6} \quad \checkmark$$

$$= 7 \text{ mm} \quad \checkmark$$

(2)

5.3 **Advantages of down cut milling:**

- A better finish is obtained. ✓
- Friction is reduced. ✓
- High speed cutting is possible. ✓
- Less power required. ✓
- Coolant is carried down to the teeth to where it is required. ✓
- Tends to force the work piece onto the machine table there for deeper cuts can be made. ✓
- Less vibration. ✓

(Any 2 x 1) (2)

5.4 **Straddle milling:**

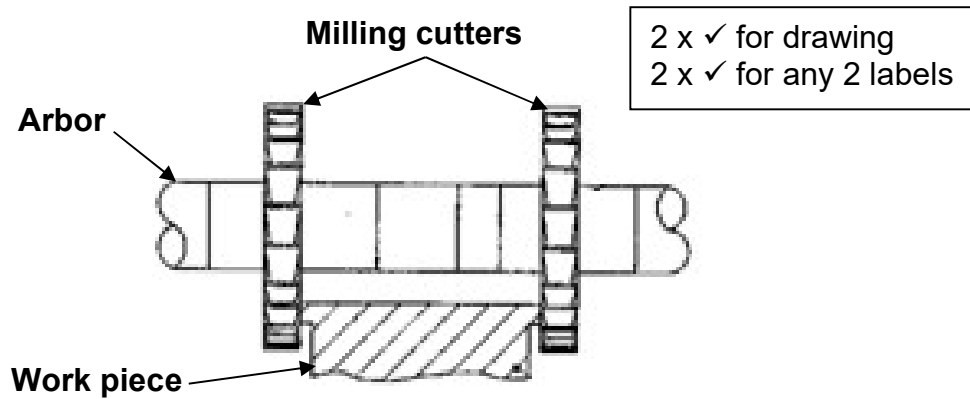

(4)
[18]

QUESTION 6: TERMINOLOGY (Indexing) (Specific)

6.1 Spur gear terminology:

6.1.1 Module:

$$\begin{aligned} \text{Module} &= \frac{\text{PCD}}{T} \\ &= \frac{126}{42} \quad \checkmark \\ &= 3 \quad \checkmark \end{aligned}$$

(2)

6.1.2 Working depth:

$$\begin{aligned} \text{WD} &= 2 \times m \quad \checkmark \\ &= 2 \times 3 \\ &= 6 \text{ mm} \quad \checkmark \end{aligned}$$

(2)

6.1.3 Cutting depth:

$$\begin{aligned} \text{Cutting depth} &= 2,157 \times m && = 2,25 \times m \\ &= 2,157 \times 3 \quad \checkmark && \text{ or } && = 2,25 \times 3 \quad \checkmark \\ &= 6,47 \text{ mm} \quad \checkmark && && = 6,75 \text{ mm} \quad \checkmark \end{aligned}$$

(2)

6.2 Angular indexing:

$$\begin{aligned} \text{Indexing} &= \frac{n}{9^\circ} = \frac{34^\circ}{9^\circ} \quad \checkmark \\ &= 3 \frac{7}{9} \times \frac{6}{6} \quad \checkmark \\ &= 3 \frac{42}{54} \quad \checkmark \end{aligned}$$

3 full turns and 42 holes on the 54 hole circle. ✓

(4)

6.3 **Indexing:**

6.3.1 **Differential indexing:**

$$\begin{aligned} \text{Indexing} &= \frac{40}{N} \\ &= \frac{40}{121} && \notin \text{ not possible} \\ \text{Chosen divisions} &= \frac{40}{A} \\ &= \frac{40}{120} \quad \checkmark \\ &= \frac{1}{3} \times \frac{8}{8} \quad \checkmark \\ &= \frac{8}{24} \quad \checkmark \end{aligned}$$

- No full turns, 8 holes on the 24 hole circle. ✓
- OR
- No full turns, 10 holes on the 30 hole circle. ✓
- OR
- No full turns, 13 holes on the 39 hole circle. ✓
- OR
- No full turns, 14 holes on the 42 hole circle. ✓
- OR
- No full turns, 17 holes on the 51 hole circle. ✓
- OR
- No full turns, 18 holes on the 54 hole circle. ✓
- OR
- No full turns, 19 holes on the 57 hole circle. ✓
- OR
- No full turns, 22 holes on the 66 hole circle. ✓

(5)

6.3.2 **Change gears:**

$$\begin{aligned} \frac{D_r}{D_n} &= \frac{A - N}{A} \times \frac{40}{1} \\ &= \frac{120 - 121}{120} \times \frac{40}{1} \quad \checkmark \\ &= \frac{-1}{120} \times \frac{40}{1} \quad \checkmark \\ &= \frac{-40}{120} \\ &= \frac{-1}{3} \times \frac{24}{24} \quad \checkmark \\ \frac{D_r}{D_n} &= \frac{24}{72} \quad \checkmark \end{aligned}$$

(5)

6.4 Calculate distance Z between rollers:

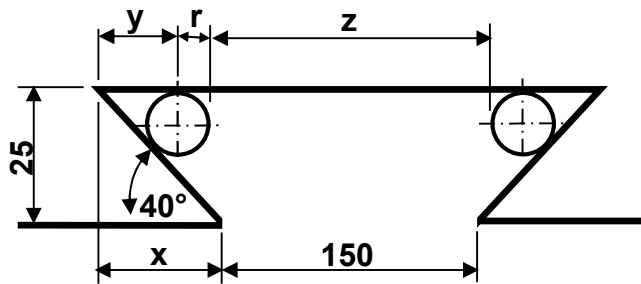

$$z = 150 + 2x - 2(y + r)$$

$$\tan 40^\circ = \frac{25}{x} \quad \checkmark$$

$$x = \frac{25}{\tan 40^\circ} = 29,79 \text{ mm} \quad \checkmark$$

$$r = \frac{d}{2} = \frac{10}{2} = 5 \text{ mm}$$

OR \checkmark

$$\tan 20^\circ = \frac{r}{y} \quad \checkmark$$

$$y = \frac{5}{\tan 20^\circ} = 13,74 \text{ mm} \quad \checkmark$$

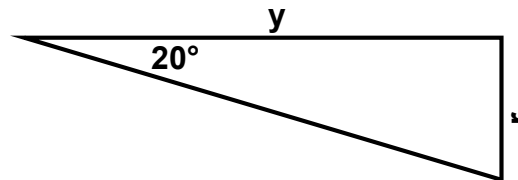
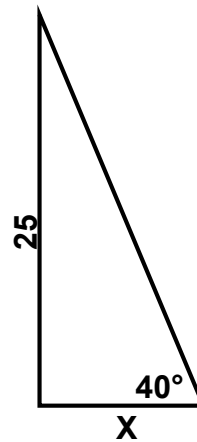

$$z = 150 + 2x - 2(y + r) \quad \checkmark$$

$$= 150 + 2(29,79) - 2(13,74 + 5) \quad \checkmark$$

$$= 150 + 59,58 - 37,48$$

$$= 172,1 \text{ mm} \quad \checkmark$$

(8)
[28]

QUESTION 7: TOOLS AND EQUIPMENT (Specific)

7.1

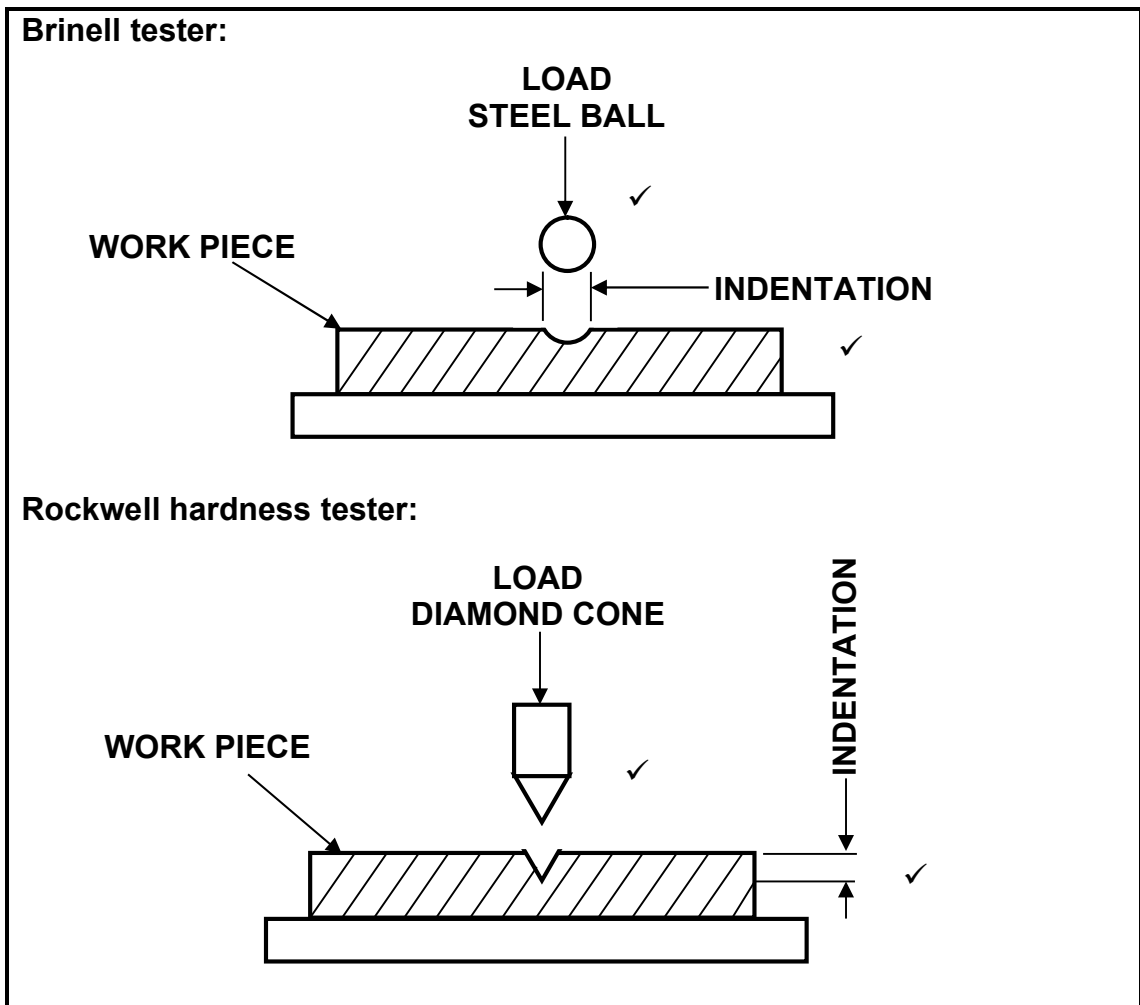

(4)

7.2

Tensile test:

- Tensile strength ✓
- Elasticity ✓
- Ductility ✓
- Plasticity ✓

(Any 2 x 1)

(2)

7.3

Depth micro-meter reading:

- 50,00 ✓
- 16,00 ✓
- 0,00 ✓
- 0,33 ✓
- 66,33 mm ✓

(5)

7.4

Screw thread ✓ micro meter ✓

(2)

[13]

QUESTION 8: FORCES (Specific)

8.1 **Equilibrant:**

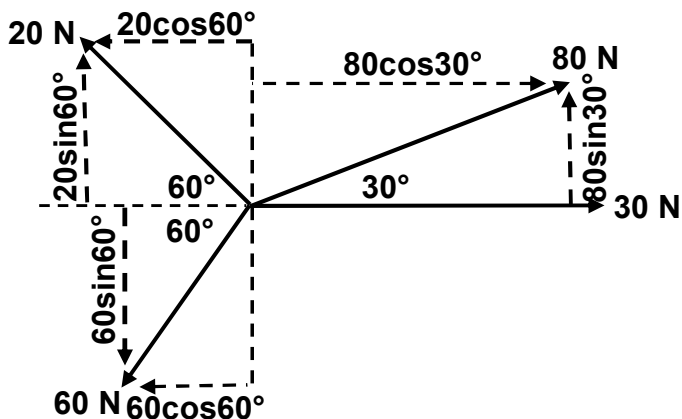

$$\begin{aligned} \sum HC &= 30 + 80\cos30^\circ - 20\cos60^\circ - 60\cos60^\circ \\ &= 30 + 69,28 - 10 - 30 \\ &= 59,28 \text{ N } \checkmark \end{aligned}$$

$$\begin{aligned} \sum VC &= 20\sin60^\circ + 80\sin30^\circ - 60\sin60^\circ \\ &= 17,32 + 40 - 51,96 \\ &= 5,36 \text{ N } \checkmark \end{aligned}$$

OR

HC	Magnitudes	VC	Magnitudes
30	30 ✓	20sin60°	17,32 ✓
80cos30°	69,28 ✓	80sin30°	40 ✓
-20cos60°	-10 ✓	-60sin60°	-51,96 ✓
-60cos60°	-30 ✓		
TOTAL	59,28 N ✓	TOTAL	5,36 N ✓

$$\begin{aligned} E^2 &= HC^2 + VC^2 \\ E &= \sqrt{59,28^2 + 5,36^2} \checkmark \\ E &= 59,52 \text{ N } \checkmark \end{aligned}$$

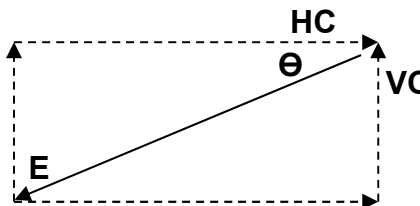

$$\begin{aligned} \tan\theta &= \frac{VC}{HC} \\ &= \frac{5,36}{59,28} \checkmark \\ \theta &= 5,17^\circ \checkmark \end{aligned}$$

E = 59,52 N at 5,17° (South from West) or
E = 59,52 N at 84,83° (West from South) or
E = 59,52 N at a bearing of 264,83°

8.2 **Moments:**

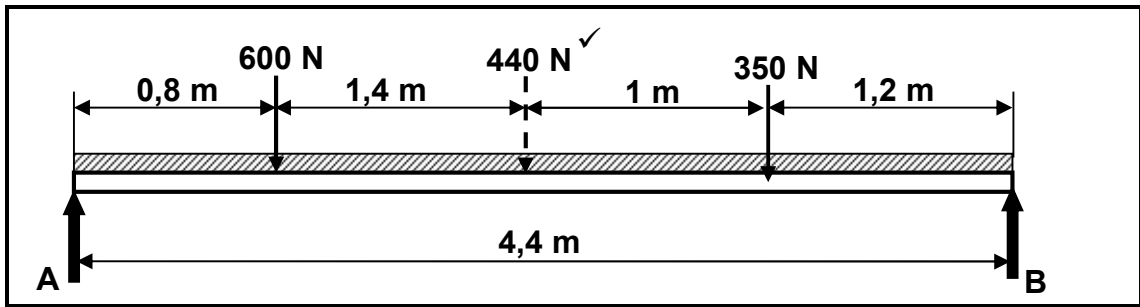

Distributed load:

$$= 100 \text{ N/m} \times 4,4 \text{ m}$$

$$= 440 \text{ N} \quad \checkmark$$

Calculate A:

Moments about B:

$$\sum \text{RHM} = \sum \text{LHM}$$

$$(A \times 4,4) = (350 \times 1,2) + (440 \times 2,2) + (600 \times 3,6) \quad \checkmark$$

$$\frac{4,4A}{4,4} = \frac{3548}{4,4} \quad \checkmark$$

$$A = 806,36 \text{ N} \quad \checkmark$$

Calculate B:

Moments about A:

$$\sum \text{LHM} = \sum \text{RHM}$$

$$(B \times 4,4) = (600 \times 0,8) + (440 \times 2,2) + (350 \times 3,2) \quad \checkmark$$

$$\frac{4,4B}{4,4} = \frac{2568}{4,4} \quad \checkmark$$

$$B = 583,64 \text{ N} \quad \checkmark$$

(8)

8.3 **Stress-strain:**

8.3.1 Compressive stress ✓ (1)

8.3.2 **Stress:**

$$A = \frac{\pi(D^2 - d^2)}{4}$$
$$= \frac{\pi(0,04^2 - 0,025^2)}{4} \quad \checkmark$$
$$A = 0,77 \times 10^{-3} \text{m}^2 \quad \checkmark$$

$$\sigma = \frac{F}{A}$$
$$= \frac{600}{0,77 \times 10^{-3}} \quad \checkmark$$
$$\sigma = 779220,78 \text{ Pa or } \left. \begin{array}{l} \\ \\ \end{array} \right\} \checkmark$$
$$= 0,78 \times 10^6 \text{ Pa or}$$
$$= 0,78 \text{ MPa} \quad \checkmark$$

(4)

8.3.3 **Change in length:**

$$E = \frac{\sigma}{\epsilon}$$
$$\epsilon = \frac{\sigma}{E} \quad \checkmark$$
$$= \frac{0,78 \times 10^6}{90 \times 10^9} \quad \checkmark$$
$$\epsilon = 8,66 \times 10^{-6} \quad \checkmark$$

$$\epsilon = \frac{\Delta l}{o l}$$
$$\Delta l = \epsilon \times o l \quad \checkmark$$
$$= (8,67 \times 10^{-6}) \times (100) \quad \checkmark$$
$$= 0,87 \times 10^{-3} \text{ mm} \quad \checkmark$$

(6)
[33]

QUESTION 9: MAINTENANCE (Specific)

9.1 Types of maintenance:

- Preventative ✓
- Predictive ✓
- Reliable centred ✓

(3)

9.2 Malfunctioning of belt drives:

- Lubrication between belt and pulley causing belt slip. ✓
- Pulleys not properly secured to shafts. ✓
- Incorrect pulley alignment. ✓
- Overloading the system. ✓
- Incorrect belt tension. ✓
- Worn belts. ✓
- Faulty / damaged tensioner pulley. ✓
- Lack of maintenance. ✓

(Any 2 x 1)

(2)

9.3 Replace the chain on a chain drive system:

- Release the tension on the chain and remove from sprocket. ✓
- Check the condition and alignment of the sprockets. ✓
- Fit the new specified chain and lubricate. ✓
- Apply adequate tension to the chain. ✓
- Check for proper operation. ✓

(5)

9.4 Wear on a gear drive system:

- Check and replenish of lubrication levels. ✓
- Ensuring the gears are properly secured to shafts. ✓
- Cleaning and replacement of oil filters. ✓
- Reporting excessive noise, wear, vibration and overheating for expert attention. ✓

(Any 2 x 1)

(2)

9.5 **Material:**

9.5.1 **Nylon:**

- Bushes ✓
- Gears ✓
- Pulleys ✓
- Fishing line ✓
- Clothing ✓
- Sails ✓
- Ropes ✓
- Sport equipment ✓
- Powder coating ✓

(Any 1 x 1) (1)

9.5.2 **Glass fibre:**

- Used in boats ✓
- Motor vehicle bodies ✓
- Transparent roof sheets ✓
- Petrol tanks ✓
- Swimming pools ✓
- Furniture ✓
- Fruit and salad bowls ✓
- Ornaments ✓
- Fishing rods ✓
- Sporting equipment ✓

(Any 1 x 1) (1)

9.6 **Thermoplastic or Thermo hardened composites:**

9.6.1 **Teflon:**

Thermoplastic ✓

(1)

9.6.2 **Bakelite:**

Thermo hardened / Thermo setting ✓

(1)

9.7 **Coefficient of friction:**

- Contact pressure ✓
- Surface roughness ✓
- Temperature ✓
- Sliding velocity ✓
- Type (amount) of lubricant ✓
- Type of material ✓

(Any 2 x 1) (2)

[18]

QUESTION 10: JOINING METHODS (Specific)

10.1 Screw thread diameters:

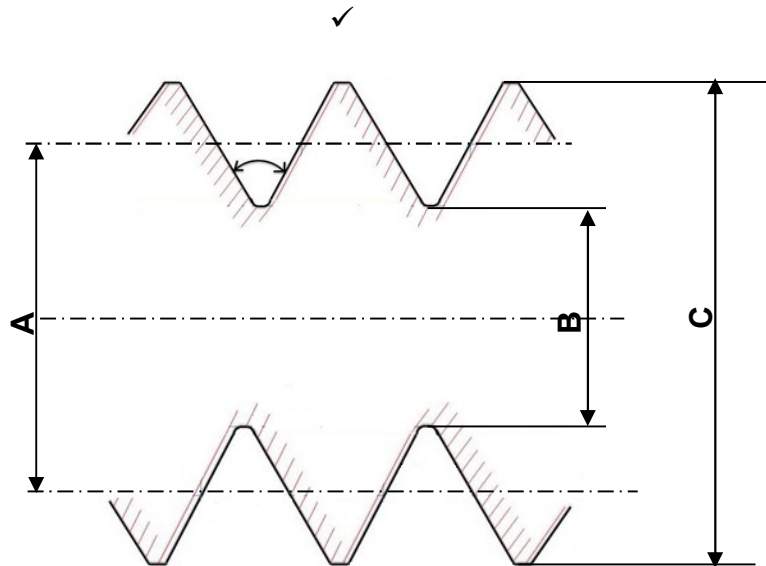

A = Pitch diameter / Effective diameter ✓

B = Minor diameter / Root diameter ✓

C = Major diameter / Crest diameter / Outside diameter / Nominal diameter / Basic diameter ✓

(4)

10.2 Lead of a screw thread:

The lead is the distance a thread ✓ will move axially ✓ in one full revolution. ✓

(3)

10.3 **Square screw thread:**

10.3.1 **Screw thread lead:**

Lead = pitch × no of starts

$$= 4 \times 3 \quad \checkmark$$

$$= 12 \text{ mm} \quad \checkmark$$

(2)

10.3.2 **Mean/pitch circumference:**

$$\text{Mean/pitch circumference} = \pi \left(\text{OD} - \frac{P}{2} \right) \quad \checkmark$$

$$= \pi \left(68 - \frac{4}{2} \right) \quad \checkmark$$

$$= 207,35 \text{ mm} \quad \checkmark$$

(3)

10.3.3 **Helix angle:**

$$\text{Helix angle } \tan \theta = \frac{\text{lead}}{\text{mean/pitch circumference}}$$

$$= \frac{12}{207,35} \quad \checkmark$$

$$\theta = 3,31^\circ \quad \checkmark$$

(2)

10.3.4 **Leading angle:**

Leading tool angle = $90^\circ - (\text{helix angle} + \text{clearance angle})$

$$= 90^\circ - (3,31^\circ + 3^\circ) \quad \checkmark$$

$$= 83,69^\circ \quad \checkmark$$

(2)

10.3.5 **Following angle:**

Following tool angle = $90^\circ + (\text{helix angle} - \text{clearance angle})$

$$= 90^\circ + (3,31^\circ - 3^\circ) \quad \checkmark$$

$$= 90,31^\circ \quad \checkmark$$

(2)

[18]

QUESTION 11: SYSTEMS AND CONTROL (Drive Systems) (Specific)

11.1 Advantages of a gear drive:

- Compact assembly ✓
- More power can be transmitted / Stronger ✓
- No slip occurs ✓
- Less maintenance ✓

(Any 2 x 1) (2)

11.2 Hydraulics:

11.2.1 Fluid pressure:

$$A_B = \frac{\pi D_B^2}{4}$$
$$= \frac{\pi(0,2)^2}{4} \quad \checkmark$$
$$= 31,42 \times 10^{-3} \text{m}^2 \quad \checkmark$$

$$P = \frac{F_B}{A_B}$$
$$= \frac{15 \times 10^3}{31,42 \times 10^{-3}} \quad \checkmark$$
$$= 477,40 \times 10^3 \text{ Pa} \quad \checkmark$$
$$= 477,40 \text{ kPa} \quad \checkmark$$

(5)

11.2.2 Distance 'X':

$$A_A = \frac{\pi D_A^2}{4}$$
$$= \frac{\pi(0,075)^2}{4} \quad \checkmark$$
$$= 4,42 \times 10^{-3} \text{m}^2 \quad \checkmark$$

$$V_B = V_A$$
$$A_B \times L_B = A_A \times L_A \quad \checkmark$$
$$L_B = \frac{A_A \times L_A}{A_B} \quad \checkmark$$
$$= \frac{(4,42 \times 10^{-3}) \times (0,12)}{(31,42 \times 10^{-3})} \quad \checkmark$$
$$= 16,88 \times 10^{-3} \text{ m}$$
$$= 16,88 \text{ mm} \quad \checkmark$$

(6)

11.3 **Advantages of pneumatics:**

- Compressed air is easy and cheap to generate. ✓
- Leakages are not messy – no oil spills. ✓
- Positive and negative pressure can be generated. ✓
- More compact. ✓
- Easily maintain due to fewer working parts. ✓

(Any 2 x 1) (2)

11.4 **Belt-drive system:**

11.4.1

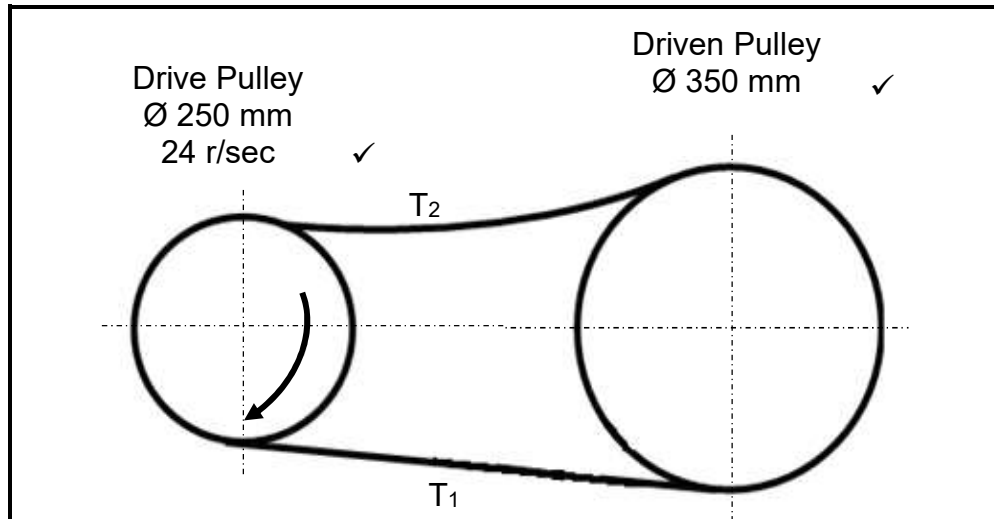

(2)

11.4.2 **Belt speed:**

$$v = \pi D n \quad \checkmark$$

$$= \pi \times 0,25 \times 24 \quad \checkmark$$

$$v = 18,85 \text{ m.s}^{-1} \quad \text{OR} \quad 18,85 \text{ m/s} \quad \checkmark$$

(3)

11.4.3 **Power transmitted:**

$P = (T_1 - T_2)v \quad \checkmark$	$P = (T_1 - T_2)\pi D n \quad \checkmark$
$= (300 - 120)18,85 \quad \checkmark$	$= (300 - 120)\pi \times 0,25 \times 24 \quad \checkmark$
$= 180 \times 18,85 \quad \checkmark$	$= 180 \times 18,85 \quad \checkmark$
$= 3393 \text{ Watt} \quad \checkmark$	$= 3393 \text{ Watt} \quad \checkmark$
$= 3,39 \text{ kW} \quad \checkmark$	$= 3,39 \text{ kW} \quad \checkmark$

OR

(4)

11.5 **Gear drive system:**
Number of teeth on gear C:

$$\frac{N_A}{N_D} = \frac{T_B \times T_D}{T_A \times T_C} \quad \checkmark$$

$$N_A = \frac{T_B \times T_D \times N_D}{T_A \times T_C} \quad \checkmark$$

$$= \frac{80 \times 60 \times 120}{30 \times 40} \quad \checkmark$$

$$= 480 \text{ r/min} \quad \checkmark$$

OR

$$N_C \times T_C = N_D \times T_D$$

$$N_C = \frac{N_D \times T_D}{T_C} \quad \checkmark$$

$$= \frac{120 \times 60}{40}$$

$$= 180 \text{ r/min} \quad \checkmark$$

$$N_A \times T_A = N_B \times T_B$$

$$N_A = \frac{N_B \times T_B}{T_A} \quad \checkmark$$

$$= \frac{180 \times 80}{30}$$

$$= 480 \text{ r/min} \quad \checkmark$$

TOTAL: (4)
[28]
200